

# SF6 PufferPak<sup>®</sup> Loadbreak Switches

■  
5kV thru 38kV Padmount, Vault  
and Poletop Applications

■  
200 Amp or 600 Amp switches tested as  
per ANSI C37.71, C37.72 and C37.60



## Contents

General Information . . . . .	Page 1
Design Features, Certified Tests and Performance . . . . .	Pages 2-3
Construction Details . . . . .	Pages 4-5
Resettable Fault Interrupters . . . . .	Pages 6-7
Padmount Switch Styles . . . . .	Pages 8-9
Subsurface and Vault Styles . . . . .	Pages 10-11
Custom Switch Applications . . . . .	Page 12
Pole Top Switch Styles . . . . .	Page 13
Standard Options and Accessories . . . . .	Pages 14-17
Typical Specifications . . . . .	Pages 18-19
Typical Installation and Operation . . . . .	Page 20

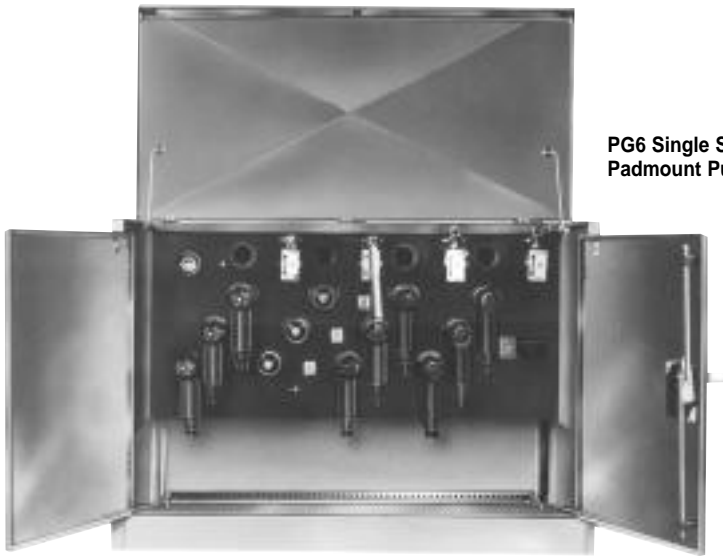

**PG6 Single Side Access  
Padmount PufferPak Switch**



**SG6 Subsurface  
PufferPak Switch**

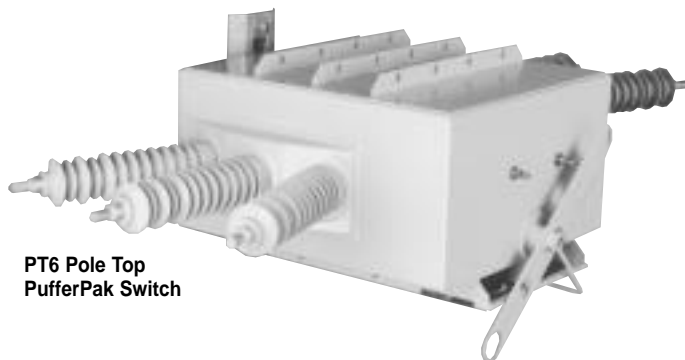

**PT6 Pole Top  
PufferPak Switch**

## General Information

### Type SG6 Subsurface Switches

PufferPak subsurface switches feature compact, sealed, corrosion-resistant construction – ideally suited for indoor, outdoor, or underground vault applications. Switch components are contained in a welded, stainless steel tank factory filled with SF6.

Subsurface switches can be mounted on floor, wall or ceiling for ease of operation, best cable training, and space utilization. Switches can be adapted to padmount applications by using optional tamper-resistant enclosures.

Subsurface switches are furnished with manual operators and standard accessories for normal installation. Units are available in a variety of circuit configurations, tank sizes, and arrangements depending upon application.

Popular options include: wall-mounted parking stands, remote or automatic switching, visible break, operational interlocks, handle position adaptors, and remote cable operators.

### Type PT6 Pole Top Switches

PufferPak Pole Top switches feature compact, sealed, corrosion-resistant construction ideally suited for outdoor pole mounted applications. Switch components are contained in a welded, stainless steel tank factory filled with SF6, making switch ideal for harsh and icy conditions.

Available in a variety of mounting configurations with the flexibility of offering a number of bushing entrances. This unit can be provided for manual or remote operation.

### Type PG6, LPG6 and HPG6 Padmount Switches

PufferPak padmount switches feature deadfront, compact, sealed, corrosion-resistant construction and low profile, tamper-resistant enclosures. Switch components are contained in a welded, steel tank factory-filled with SF6. Maintenance is minimized since performance is unaffected by contamination, rodents and flooding.

Padmount enclosures are removable for easy installation and maintenance. Switch accessories, operating handles, and elbow connections are located for ease of operation and cable training with access through hinged doors and hood.

Padmount switches are furnished with manual operators and standard accessories for normal installation. Units are available with single-side access for limited space application or double-side access with separate compartments for incoming and outgoing circuits.

Popular options include: remote or automatic switching; visible break; operational interlocks; and parking stands.

### Type SRG6 and PRG6 Fault Interrupter Switches

The Resettable Fault Interrupter (RFI) is an electronically controlled vacuum interrupter offering three phase short circuit protection. Available as a stand alone product or combined with the field proven PufferPak loadbreak switch it offers deadfront, compact, sealed and corrosion resistant construction. The RFI mechanism can be packaged in a vault or padmount style, still offering all the benefits associated with the SF6 technology.

The reliable, microprocessor controlled vacuum interrupter eliminates the need to replace or stock fusing. The RFI module is a 600 A loadbreak device with a 12kA symmetrical fault interrupting rating. The electronics are self powered, user friendly devices offering the ability to field adjust characteristics and settings.

Resettable Fault Interrupter switches are furnished with manual operators, visual position indicators and standard accessories for normal installation. Units are available in a variety of circuit configurations, tank sizes and arrangements depending upon application.

Popular options include: remote or automatic switching, visible break (PufferPak only), operational interlocks, and parking stands.

### Other Designs and Applications

PufferPak vault, subsurface and padmount switching products are constantly changing. Please consult the factory for the latest information and catalog supplements.

## Design Features

### Switch Design

PufferPak SF6 switches are designed and constructed to provide economical, safe and reliable switching in a small, light-weight package. Using SF6 for insulation and arc-interruption eliminates space, weight and maintenance costs, as well as hazards associated with vacuum, air or oil-filled equipment. In addition, PufferPak switches provide improved interrupting and open gap performance.

Switches can be mounted in any position and any environment, including Class 1, Division 1, hazardous locations. Maintenance is minimized with sealed construction that is unaffected by contamination, rodents, or floods.

Switch components are contained in a welded, mild or stainless steel tank factory-filled with SF6, eliminating exposed live parts and providing complete deadfront operation.



SF6 Puffer action is self-generating using the SF6 contained in the switch tank. Arc extinction occurs at first current zero.

### SF6 Dielectric

Sulfur hexafluoride gas (SF6) contributes to the safety, insulating and load-interrupting performance of PufferPak switches. SF6 is non-flammable, non-toxic, colorless and odorless. At 0 PSIG, SF6 has 2½ times the insulating quality of dry air. Under moderate pressure, insulating and arc-extinguishing qualities increase.

PufferPak switches are shipped pre-filled with SF6, and are electrically tested and leak-tested to insure proper operation. Inside the switch tank, a special absorbent neutralizes any possible arc by-products, reducing field maintenance to an occasional check of the color-coded pressure gauge.

### Puffer Action

The PufferPak switch capitalizes on the pressure/insulation curve of SF6, as well as the electronegative characteristics of the gas and its ability to absorb and transfer heat and free electrons rapidly from an arc.

To amplify the arc-extinguishing abilities of SF6, the switch incorporates a patented, self-generating puffer action that forces a pressurized stream of SF6 through the contact area during switching. This increased pressure increases the insulation level while simultaneously cooling and extinguishing the arc. In the full-open position, the contacts are separated by a 3" open gap, giving a 200 kV BIL flashover withstand.

### Contact System

PufferPak switches feature self-aligning pin-and-socket contacts constructed of silver-plated copper with tungsten-copper arcing tips. Contacts are designed to prevent damage to main contact surfaces during operation, and provide increased contact pressure with increased currents in the closed position.

PufferPak switches incorporate self-cleaning, wiping-type contacts along with Belleville washers and locking fasteners at critical current connections for long life and maintenance-free operation.

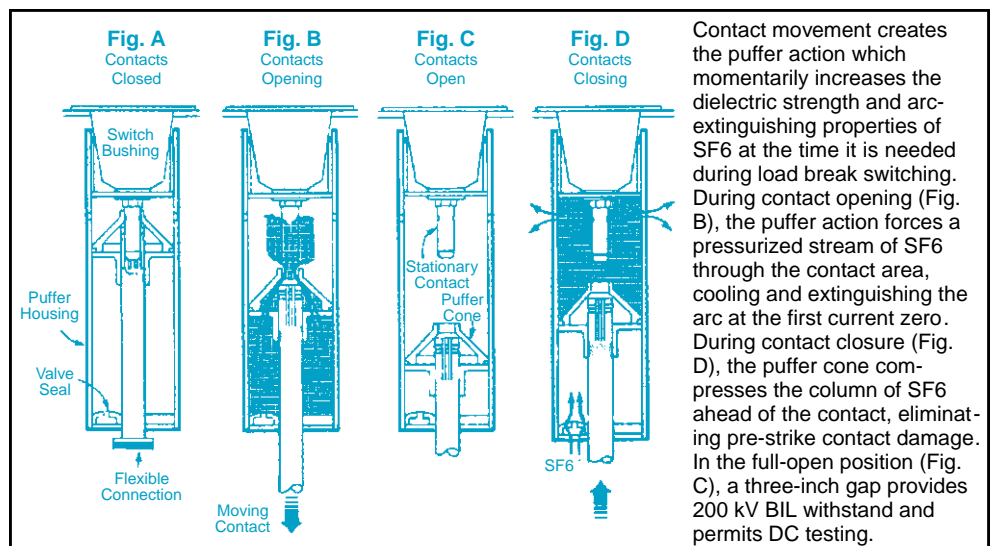

## Certified Tests and Performance

The following data are the result of tests on standard production PufferPak load break switches. The switches were tested per applicable portions of IEEE, ANSI, NEMA, and other industry standards including:

- ANSI C37.71 Standard for Subsurface Load Interrupting Switches.
- ANSI C37.72 Standard for Padmount Load Interrupting Switches.
- ANSI C37.60 Standard for Fault Interrupters

- ANSI/IEEE 386 Standard for Separable Connectors and Bushings.
- IEC 265 International Standards for Load Interrupting Switches.
- ASTM D-2472 Specification for Commercial Type Electrical Grade SF6.
- ANSI C57.12.28 Standard for Padmount Enclosures

Tests were conducted at recognized, independent power testing laboratories, including KEMA in Holland. Test results were verified by oscillograms and high-speed

movies. As required by ANSI standards, all tests were performed in a specific sequence without any maintenance to the switch or SF6. Tests were conducted at 15.5, 27, and 38 kV levels on approximately 75 different switches including 2-, 3-, and 4-way configurations. To simulate actual service conditions, the tests were run at various SF6 gas pressures and with switches mounted in typical subsurface and padmount applications.

Voltage Ratings					
Maximum Design Voltage	15.5 kV	27 kV	38kV	15.5 kV RFI	27 kV RFI
Frequency	50/60 Hz	50/60 Hz	50/60 Hz	50/60 Hz	50/60 Hz
BIL Impulse withstand	95 kV	125kV	150 kV	95 kV	125 kV
One minute AC withstand	35 kV	60 kV	70 kV	35 kV	50 kV
Fifteen minute DC withstand	66 kV	96 kV	103 kV	53 kV	78 kV
Corona extinction	11 kV	19 kV	26 kV	11 kV	19 kV
Open Gap BIL Flashover withstand	200 kV	200 kV	200 kV	95 kV	125 kV

Current Ratings					
Load interrupting and loop switching	600 A	600 A	600 A	600 A	600 A
Transformer magnetizing interrupting	25 A	25 A	25 A	25 A	21 A
Capacitor or cable charging interrupting	40 A	40 A	40 A	40 A	25 A
Asymmetrical momentary and 3 operation fault close - standard. (Optional ratings)*	22,500 A (32,000 A) (40,000 A)	22,500 A (32,000 A) (40,000 A)	22,500 A (32,000 A)	19,200 A	19,200 A
Symmetrical one second rating - standard. (Optional ratings)*	15,000 A (20,000 A) (25,000 A)	15,000 A (20,000 A) (25,000 A)	15,000 A (20,000 A)	12,000 A	12,000 A
Continuous current	600 A	600 A	600 A	600 A	600 A
8 hour overload current	900 A	900 A	900 A		
Overload interrupting capability	3,000 A	2,500 A	2,000 A	12,000 A	12,000 A
Operations - 600 A load interrupting endurance	1,000	1,000	1,000		
Symmetrical 10 cycle phase to phase simulated internal fault withstand	12,500 A	12,500 A	12,500 A		

Application Information and Mechanical Ratings	
Sealing systems	10 <sup>-7</sup> cc/second maximum gas leakage
Ambient temperature range	-40 to +120 degrees Fahrenheit
Corrosion resistance per ASTM B-117	2000 hours minimum
Mechanical life	2000 operations
SF6 gas normal operating pressure range	2-15 PSIG

\*Above ratings may be reduced due to entrances and bushings selected.

## Construction Details

**Steel switch tank** contains the SF6 and provides corrosion-resistant protection for the internal parts. All seams and components are T.I.G. welded, utilizing stainless filler rod to assure leak-tight construction.

All external components and accessories are 300 series stainless steel or bronze.

**Mounting provisions** include four  $\frac{9}{16}$ " diameter holes in bottom channels on subsurface switches. Padmount switches are supported by a galvanized steel frame with four  $\frac{9}{16}$ " diameter mounting holes at the bottom.

The padmount enclosure is removable, and separate from the switch. It is mounted to the pad with four 1" diameter concealed holes in the bottom flange.

**Lifting provisions** consist of two welded lift eyes at opposite corners on subsurface and padmount switches. Padmount enclosures are equipped with recessed  $\frac{5}{8}$ " - 11 blind threaded holes at four corners.



Subsurface switch

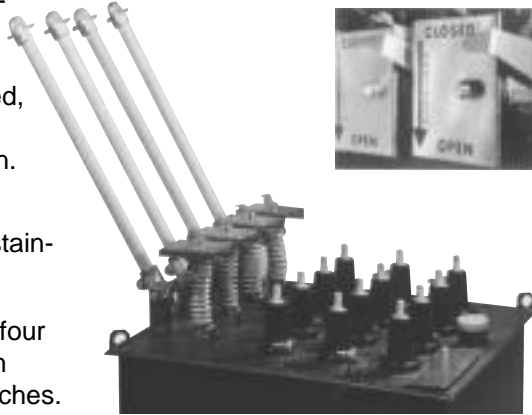

Switch operating handles may be actuated by hookstick or rope. Handles can be permanently installed, or removed and stored. Operating handle movement is clearly labeled and provides positive position indication. Padlock provisions allow locking in either the open or closed positions.

**All welded switch construction** is standard, eliminating gaskets and O-ring seals for leak-tight, maintenance-free service. Bushings are T.I.G. welded to the switch tank.

Operating shafts are sealed by an internal, flexible, stainless steel bellows and equipped with an external protective boot.



bushing



bellows



**Nameplates** clearly show rating information, bushing-oriented circuit diagram, and phase identification for ease of installation and operation of the switch.



**Pressure gauge** is color-coded for easy reading of correct pressure and operating range. Mechanical protection is provided by a transparent protective dome.



**Brass fill valve**, sealed and protected by a threaded brass cap, operates similarly to a tire valve and provides access for filling or addition of SF6.

**Bronze ground lugs** located next to each set of bushings provide quick convenient connection of tank and cable to system ground.



## Construction Details

**Padmount enclosures** are of tamper-resistant construction; they are made of 12-gauge steel, stiffened and cross-kinked for rigidity, painted with zinc rich primer and two final coats of dark green finish. Easy opening double doors and hinged hood are provided for full access. Construction includes stainless steel hardware, wind stops, penta-head security bolt, recessed padlock provisions and 3-point latching.

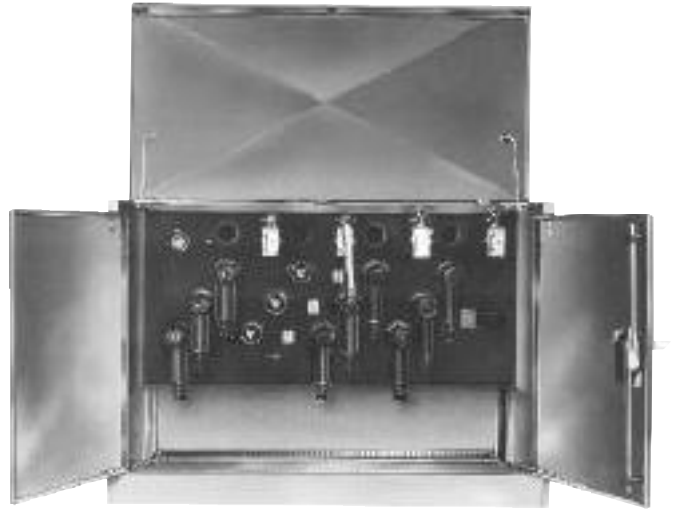

**Type HPG6 Padmount switches** are equipped with a lightweight easy opening hood for access to switch and cable compartment.



**Padmount enclosure door handles** are recessed and include padlock provision. Penta-head bolt is standard.

# Resettable Fault Interrupters Padmount Style

## Switch Ratings

15.5 and 27 kV voltage classes

600 or 200 Amp continuous and load break switching

Standard 12kA SYM momentary and fault close

## Fault Interrupting Capability

12kA SYM fault interrupting

Field selectable trip settings of 30 Amp to 600 Amp

Field selectable time current curves - "E" and "K" speeds

## Styles

2-, 3-, 4- or 5-way circuit configurations





600 Amp deadbreak or 200 Amp deep-well elbow connections

Three phase interruption

## Standard Features

- All welded mild steel switch tank, factory assembled, tested, and filled with SF6.
- Self powered electronically controlled resettable fault interrupter providing three phase circuit protection.
- NEMA 4 electronic enclosure standard. NEMA 6P optional.
- Removable operating handle with padlock provisions, position indicators, provision for operation by hookstick or rope, and handle storage.
- 200 Amp deepwell or 600 Amp bushings furnished with protective shipping caps and one ground lug per set of bushings.
- Phase identification tags, nameplate with ratings and connection diagram.
- Color-coded pressure gauge with separate fill valve.
- Lifting and mounting provisions.
- Optional parking stands for cable connections available.
- 12-gauge mild steel, tamper-resistant, single-side access padmount enclosure with 3-point latch double doors and hinged hood.
- Enclosure equipped with stainless steel hardware, wind stops, padlock provision and penta-head bolt. Enclosure painted dark green.

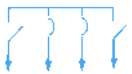

Switch Configuration	Catalog Number	Model Number	Max kV	W Dim. In.	H Dim. In.	D Dim. In.	Wt. Lbs. Approx.
 <b>2 WAY</b>	PRG6-22-15 PRG6-22-27	6T 6T	15.5 27	41	45	52	725
 <b>3 WAY</b>	PRG6-33-15 PRG6-33-27	6T6 6T6	15.5 27	53	45	52	925
 <b>4 WAY</b>	PRG6-44-15 PRG6-44-27	6TT6 6TT6	15.5 27	65	45	52	1175
 <b>5 WAY</b>	PRG6-55-15 PRG6-55-27	6TTT6 6TTT6	15.5 27	65	45	52	1175

**Notes:** Consult factory for other configurations.  
 Replace "6" with "2" in model number for 200A deepwell bushings.  
 Replace "T" with "S" in model number for 600A apparatus bushings on RFI ways.



## Vault and Subsurface Style

### Switch Ratings

15.5 and 27 kV voltage classes

600 or 200 Amp continuous and load break switching

Standard 12kA SYM momentary and fault close

### Fault Interrupting Capability

12kA SYM fault interrupting

Field selectable trip settings of 30 Amp to 600 Amp

Field selectable time current curves - "E" and "K" speeds

### Styles

2-, 3-, 4-, 5- or 6-way circuit configurations





600 Amp deadbreak or 200 Amp deep-well elbow connections

Three phase interruption

### Standard Features

- All welded stainless steel switch tank, factory assembled, tested, and filled with SF6.
- Self powered electronically controlled resettable fault interrupter providing three phase circuit protection.
- NEMA 4 electronic enclosure, standard. NEMA 6P available.

- Removable operating handle with padlock provisions, position indicators, provision for operation by hookstick or rope, and handle storage.
- 200 Amp deepwell or 600 Amp bushings furnished with protective shipping caps and one ground lug per set of bushings.
- Phase identification tags, nameplate with ratings and connection diagram.
- Color-coded pressure gauge with separate fill valve.
- Lifting and mounting provisions.

Switch Configuration	Catalog Number	Model Number	Max kV	W Dim. In.	H Dim. In.	D Dim. In.	Wt. Lbs. Approx.
 2 WAY	SRG6-22-15 SRG6-22-27	6T 6T	15.5 27	20	23.3	30	210
 3 WAY	SRG6-33-15 SRG6-33-27	6T6 6T6	15.5 27	25	23.3	30	320
 4 WAY	SRG6-44-15 SRG6-44-27	6TT6 6TT6	15.5 27	36.5	23.3	30	550
 5 WAY	SRG6-55-15 SRG6-55-27	6TTT6 6TTT6	15.5 27	48.5	23.3	30	700
 6 WAY	SRG6-66-15 SRG6-66-27	6TTTT6 6TTTT6	15.5 27	60.5	23.3	30	850

**Notes:** Consult factory for other configurations.

Replace "6" with "2" in model number for 200A deepwell bushings.

Replace "T" with "S" in model number for 600A apparatus bushings on RFI ways.



# Padmount Applications

## Ratings

15.5, 27, and 38 kV voltage classes

600 or 200 Amp continuous and load break switching

Standard 22.5 kA ASYM momentary and fault close

Optional 32/40 kA ASYM momentary and fault close\*

## Styles

2, 3, or 4-way circuit configurations

600 Amp deadbreak or 200 Amp deepwell elbow connections





Three phase or single phase

## Standard Features

- All welded mild steel switch tank, factory assembled, tested, and filled with SF6.

**Ordering Information:** Select switch configuration and voltage class, specify catalog number, model number and options.

### THREE PHASE AND SINGLE PHASE SINGLE SIDE ACCESS PADMOUNT SWITCHES

Switch Configuration	3-Phase Catalog Number	1-Phase Catalog Number	Model Number Replace "X" with "2" for 200 A Bushing "6" for 600 A Busing	Max kV	Width* Dim. Inches	Wt.* Lbs. Approx
 <b>2 WAY - 1 SWITCHED</b>	PG6-21-15	PG61-21-15	X X	15.5	41	700
	PG6-21-27	PG61-21-27	X X	27		
	PG6-21-38	PG61-21-38	X X	38		
 <b>3 WAY - 2 SWITCHED</b>	PG6-32-15	PG61-32-15	X X X	15.5	53	1100
	PG6-32-27	PG61-32-27	X X X	27		
	PG6-32-38	PG61-32-38	X X X	38		
 <b>3 WAY - 3 SWITCHED</b>	PG6-33-15	PG61-33-15	X X X	15.5	53	1200
	PG6-33-27	PG61-33-27	X X X	27		
	PG6-33-38	PG61-33-38	X X X	38		
 <b>4 WAY - 2 SWITCHED</b>	PG6-42-15	PG61-42-15	X X X X	15.5	65	1400
	PG6-42-27	PG61-42-27	X X X X	27		
	PG6-42-38	PG61-42-38	X X X X	38		
 <b>4 WAY - 4 SWITCHED</b>	PG6-44-15	PG61-44-15	X X X X	15.5	65	1600
	PG6-44-27	PG61-44-27	X X X X	27		
	PG6-44-38	PG61-44-38	X X X X	38		

\* Width and Wt. shown is for 3 phase switches. For 1 phase switches: W = 41" for all units and Wt. is as follows: 2 way = 300 lbs.; 3 way = 400 lbs.; 4 way = 500 lbs.

+ To specify optional 32/40kA ASYM rating add /32/40 to catalog number. Example: PG6-21-15/32.

- Removable operating handle with padlock provisions, position indicators, provision for operation by hookstick or rope, and handle storage.
- 200 Amp deepwell or 600 Amp bushings furnished with protective shipping caps and one ground lug per set of bushings.
- Phase identification tags, nameplate with ratings and connection diagram.
- Color-coded pressure gauge and brass fill valve.
- Lifting and mounting provisions.

- 12-gauge mild steel, tamper-resistant, single-side access padmount enclosure with 3-point latch double doors and hinged hood. Equipped with stainless steel hardware, wind stops, padlock provision and penta-head bolt. Enclosure painted dark green.

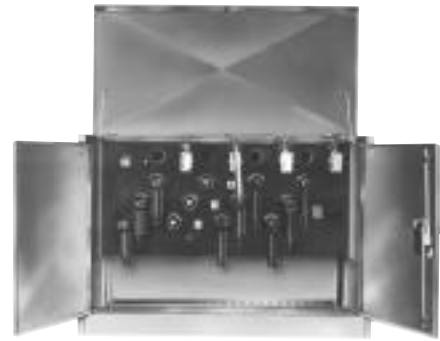

Three Phase PG6 Single Side Access Padmount Switch

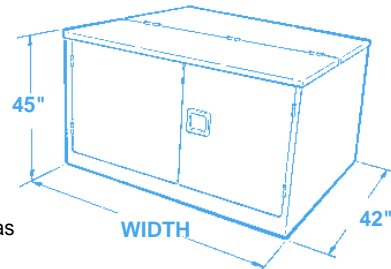
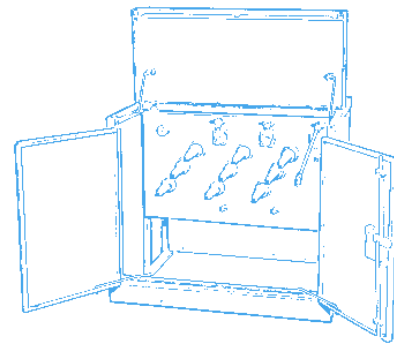

**LPG Low Profile Padmount Switches**

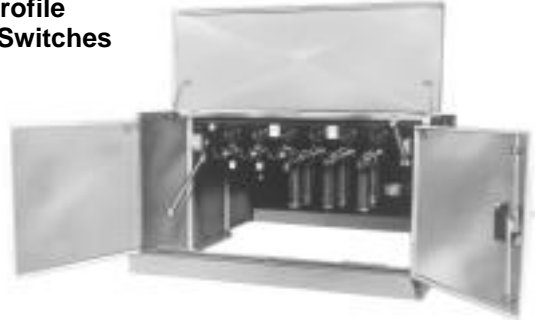



PufferPak LPG low profile padmount switches are designed and constructed per ANSI standard C37.72. Bushings, parking stands and operating handles are located to allow hookstick operation.

Three and four-way switches incorporate double-sided access to the operating compartments. Units are 40" high x 72" wide x 84" deep.

**Ordering Information:** Select switch configuration and voltage class. Specify catalog number, model number and options.

**THREE PHASE LOW PROFILE PADMOUNT SWITCHES**

Switch Configuration	3-Phase Catalog Number	Model Number Replace "X" with "2" for 200 A Busing "6" for 600 A Busing	Max kV	Wt. Lbs. Approx.
 <b>3 WAY - 3 SWITCHED</b>	LPG6-33-15	X X X	15.5	1400
	LPG6-33-27	X X X	27	
	LPG6-33-38	X X X	38	
 <b>4 WAY - 4 SWITCHED</b>	LPG6-44-15	X X X X	15.5	1600
	LPG6-44-27	X X X X	27	
	LPG6-44-38	X X X X	38	

**Note:** 32/40 kA ASYM rating not available on LPG switches.

**Optional Padmount Enclosures**

12 Gauge Steel, Tamper-Resistant Construction, Painted Green

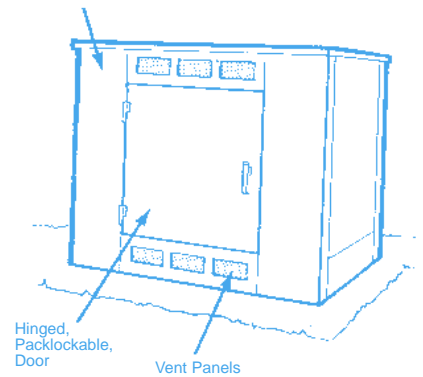

Standard PufferPak subsurface switches may be adapted for use in padmount applications by specifying an Optional Padmount Enclosure shown on page 15. The enclosure will house any of the subsurface switches shown on pages 10 thru 12. The result is an attractive, tamper-resistant padmount switch with plenty of room for installation, operation and cable training.

**Single Phase PG6 Single Side Access Padmount Switch**

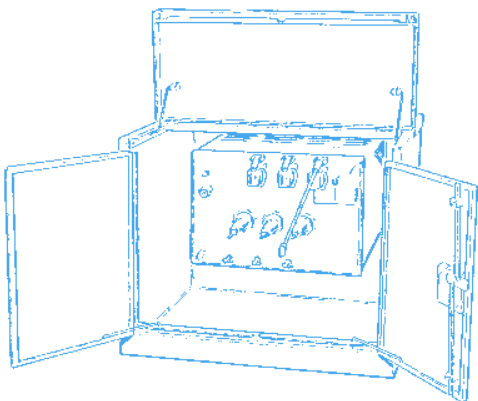

**Single or Three Phase HPG6 Padmount Switches with Hinged Access Hood**

To order hooded style padmount switch, refer to PG6 catalog information on page 8, adding H to catalog number. For example, HPG6-44-15.



# Subsurface and Vault Applications

## Ratings

15.5, 27, and 38 kV voltage classes

600 or 200 Amp continuous and load break switching

Standard 22.5 kA ASYM momentary and fault close

Optional 32/40 kA ASYM momentary and fault close\*

## Styles

2, 3, or 4-way circuit configurations

600 Amp deadbreak or 200 Amp deepwell elbow connections

Three phase or single phase

## Standard Features

- All welded stainless steel switch tank, factory assembled, tested, and filled with SF6.
- Removable operating handles with padlock provisions, position indicators, provision for operation by hookstick or rope.
- 200 Amp deepwell or 600 Amp bushings furnished with protective shipping caps and one ground lug per set of bushings.
- Phase identification tags, nameplate with ratings and connection diagram.

- Color-coded pressure gauge and brass fill valve.
- Lifting and mounting provisions.



Three Phase Subsurface Switch

**Ordering Information:** Select switch configuration and voltage class, specify catalog number, model number and options.

### THREE PHASE SUBSURFACE SWITCHES

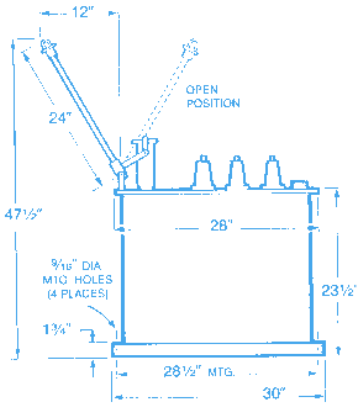

SIDE VIEW



FRONT VIEW

Switch Configuration	Catalog Number	Model Number Replace "X" with "2" for 200 A Bushing "6" for 600 A Busing	Max kV	Wt. Lbs. Approx.	Width* Dim. Inches
2 WAY - 1 SWITCHED	SG6-21-15	X X	15.5	150	16 1/2
	SG6-21-27	X X	27		
	SG6-21-38	X X	38		
3 WAY - 3 SWITCHED	SG6-33-15	X X X	15.5	225	20
	SG6-33-27	X X X	27		
	SG6-33-38	X X X	38		
3 WAY - 2 SWITCHED	SG6-32-15	X X X	15.5	200	20
	SG6-32-27	X X X	27		
	SG6-32-38	X X X	38		
4 WAY - 4 SWITCHED	SG6-44-15	X X X X	15.5	300	25
	SG6-44-27	X X X X	27		
	SG6-44-38	X X X X	38		
4 WAY - 3 SWITCHED	SG6-43-15	X X X X	15.5	275	25
	SG6-43-27	X X X X	27		
	SG6-43-38	X X X X	38		
4 WAY - 2 SWITCHED	SG6-42-15	X X X X	15.5	250	25
	SG6-42-27	X X X X	27		
	SG6-42-38	X X X X	38		
3 WAY - 3 SWITCHED	SG6-33-15/SV	X X X	15.5	225	25
	SG6-33-27/SV	X X X	27		
	SG6-33-38/SV	X X X	38		
4 WAY - 4 SWITCHED	SG6-44-15/SV	X X X X	15.5	450	36 1/2
	SG6-44-27/SV	X X X X	27		
	SG6-44-38/SV	X X X X	38		

+ Note: To specify 32/40 kA ASYM optional rating add /XX to Catalog Number.  
Example: SG6-21-15/32 OR SG6-21-15/40.

\* Spread Version - Bushings spaced for direct elbow connection.





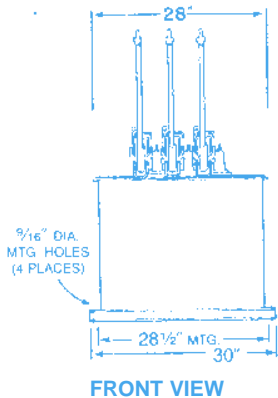
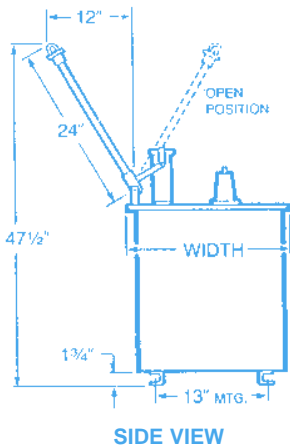

# Subsurface and Vault Applications



Single Phase Subsurface Switch



## SINGLE PHASE SUBSURFACE SWITCHES

Switch Configuration	Catalog Number	Model Number Replace "X" with "2" for 200 A Bushing "6" for 600 A Busing	Max. kV	Wt. Lbs. Approx.	Width Inches
 <b>2 WAY - 1 SWITCHED</b>	SG61-21-15	X X	15.5	100	16 1/2
	SG61-21-27	X X	27		
	SG61-21-38	X X	38		
 <b>3 WAY - 3 SWITCHED</b>	SG61-33-15	X X X	15.5	175	20
	SG61-33-27	X X X	27		
	SG61-33-38	X X X	38		
 <b>3 WAY - 2 SWITCHED</b>	SG61-32-15	X X X	15.5	150	20
	SG61-32-27	X X X	27		
	SG61-32-38	X X X	38		
 <b>4 WAY - 4 SWITCHED</b>	SG61-44-15	X X X X	15.5	250	25
	SG61-44-27	X X X X	27		
	SG61-44-38	X X X X	38		
 <b>4 WAY - 3 SWITCHED</b>	SG61-43-15	X X X X	15.5	225	25
	SG61-43-27	X X X X	27		
	SG61-43-38	X X X X	38		
 <b>4 WAY - 2 SWITCHED</b>	SG61-42-15	X X X X	15.5	200	25
	SG61-42-27	X X X X	27		
	SG61-42-38	X X X X	38		

+ Note: To specify 32/40 kA ASYM optional rating add /XX to Catalog Number.  
Example: SG6-21-15/32 OR SG6-21-15/40.

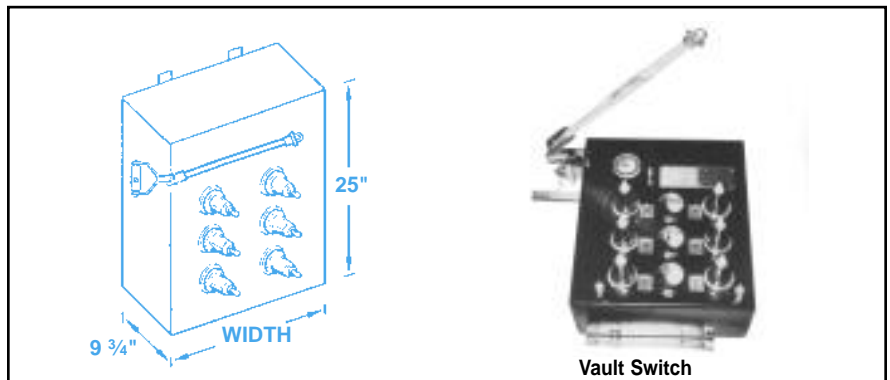

Vault Switch

## THREE PHASE VAULT SWITCHES

Switch Configuration	Catalog Number	Model Number Replace "X" with "2" for 200 A Bushing "6" for 600 A Busing	Max kV	Wt. Lbs. Approx.	Width Dim. Inches
 <b>2 WAY - 1 SWITCHED</b>	VG6-21-15	X X	15.5	140	21 1/2
	VG6-21-27	X X	27		
	VG6-21-38	X X	38		

+ Note: To specify 32/40 kA ASYM optional rating add /XX to Catalog Number.  
Example: VG6-21-15/32 or VG6-21-15/40.

## Custom Switching Applications

PufferPak designs are modular in concept, permitting a wide variety of switching configurations to meet particular application needs. Custom designs tailor the standard PufferPak construction features to specific switching requirements

### Top/End Subsurface Switches

Top/End subsurface switches are an example of the flexibility available in PufferPak switches. This unit locates the cable connection bushings on the sides as well as the top of the switch, to provide a compact unit with increased cable training versatility.

### Custom Circuit Configurations

5-way, 6-way and double-loop switches are examples of the custom circuit configurations available with PufferPak switches. The 5- and 6-way switches extend the number of circuit connections available in a single tank enclosure. Double-loop switches incorporate a bus-tie configuration for load splitting and balancing.

### Special Ratings

PufferPak switches are available with ratings to match the most severe system requirements including special operating voltages, higher impulse withstand, and 32/40 kA ASYM momentary/fault close ratings. Please contact the factory for further information and application assistance.

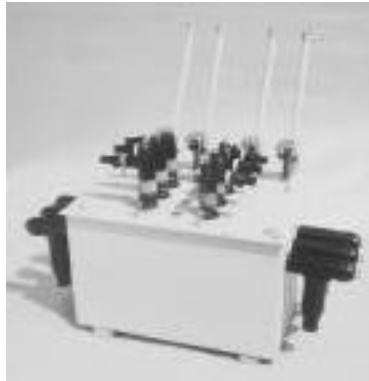



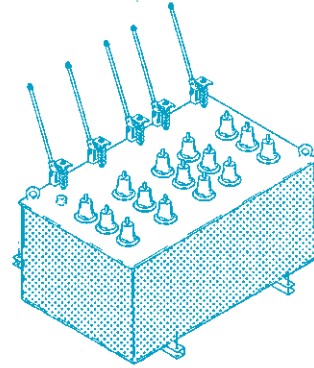



TG6 switch with top-end bushing arrangement.



SG6 switch with top mounted spread version bushing arrangement.

### TOP/END SWITCHES AND 4-WAY THRU 6-WAY SWITCHES

**Ordering Information:** Select switch configuration and voltage class, specify catalog number, model number and options.

Switch Configuration	TG6 Cat.No. Replace "XX" with 15 for 15.5 kV, 27 for 27 kV or 38 for 38 kV	SG6 Cat.No.	MODEL NUMBER Replace "X" with "2" for 200 A Bushing "6" for 600 A Bushing	TG6* Width Inches	TG6 Wt.Lbs. Approx.	SG6* Width Inches	SG6 Wt. Lbs. Approx.
 4 WAY - 4 SWITCHED	N/A	SG6-44-XX	X X X X	N/A	N/A	25	300
	TG6-44-XX/SV	SG6-44-XX/SV	X X X X	36½	450	36½	450
 5 WAY - 5 SWITCHED	TG6-55-XX	SG6-55-XX	X X X X X	36½	475	36½	475
	TG6-55-XX/SV	SG6-55-XX/SV	X X X X X	48½	550	48½	550
 6 WAY - 6 SWITCHED	N/A	SG6-66-XX	X X X X X X	N/A	N/A	36½	500
	TG6-66-XX/SV	SG6-66-XX/SV	X X X X X X	48½	575	60½	650
 4 WAY - DOUBLELOOP	N/A	SG6-45-XX	X X X X	N/A	N/A	36 ½	475
	TG6-45-XX/SV	SG6-45-XX/SV	X X X X	48½	550	48½	550
 5 WAY - DOUBLELOOP	N/A	SG6-56-XX	X X X X X	N/A	N/A	48½	575
	TG6-56-XX/SV	SG6-56-XX/SV	X X X X X	48½	575	60½	650
 6 WAY - DOUBLELOOP	TG6-67-XX	SG6-67-XX	X X X X X X	48½	600	48½	600
	TG6-67-XX/SV	SG6-67-XX/SV	X X X X X X	60½	675	60½	675

N/A = Design not available

\*See page 10 for additional dimensional information.

# Pole Top Switches

## Ratings

15.5, 27 and 38 kV voltage classes

600 Amp continuous and load break

22.5 kA ASYM momentary and fault close standard

Consult factory for 32 kA ratings

## Style

2-way, 3-phase group operated

## Standard Features

- All welded, stainless steel sealed construction.
- Horizon Grey finish coating keyed to environment.
- SF6-Puffer arc-quenching, load-break technology.
- Factory tested and filled with SF6.
- Crossarm mounting w/ j-bolts and lifting provisions.
- Manual operating lever w/ hook-stick provisions.
- Positive position indicators w/ padlock provisions.
- Molded rubber insulators for line connections.
- 200 Amp deepwell or 600 Amp bushings for elbow connections.
- Corrosion-resistant nameplate w/ rating and line diagram.
- Color-coded pressure gauge with separate fill valve.

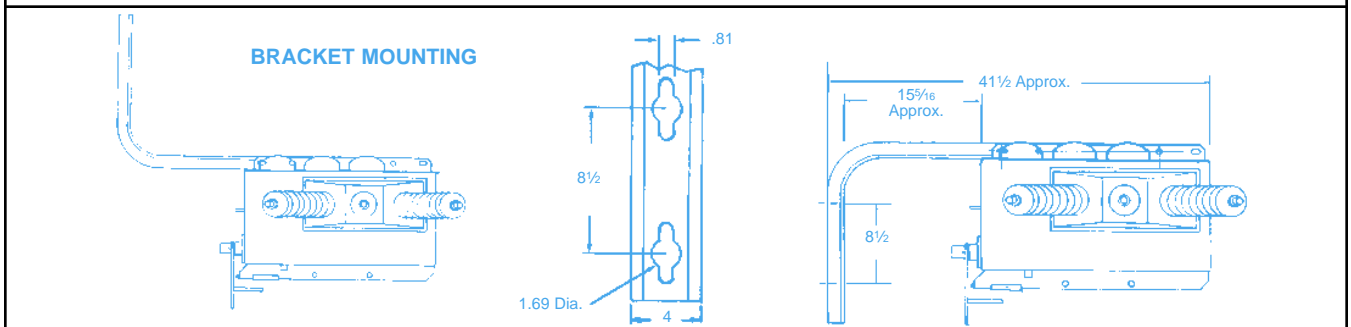
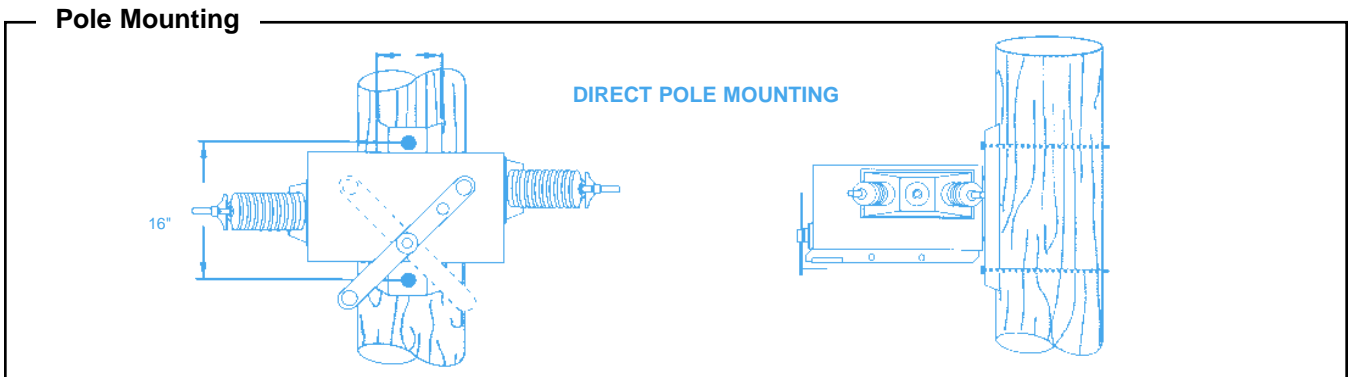
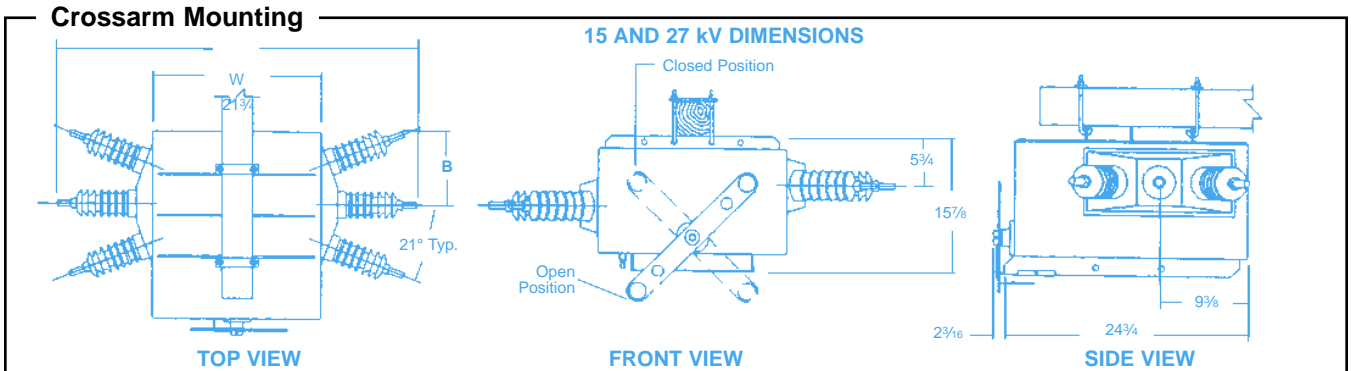

## Standard Options and Accessories

Puffer Pak subsurface, padmount, and pole top switches can be customized for a particular application using the standard options and accessories summarized here.

		Resettable Fault Interrupter (RFI)	Vault/Subsurface Models	Padmount Models Single Side Access	Pole Top Models
1	SF6 puffer load break switching with ratings and performance per ANSI C37.71, C37.72 and C37.60	S	S	S	S
2	Deadfront, submersible, non-venting, corrosion-resistant construction	S	S	-	-
3	Spring operated manual switching with positive position indication and padlock provisions	S	S	S	S
4	Mounting, lifting, grounding provisions	S	S	S	S
5	Phase identification, circuit diagram and rating nameplates	S	S	S	S
6	SF6 pressure gauge and fill valve	S	S	S	S
7	Provision for 200A or 600A elbow connections	S	S	S	S
8	Three-phase resettable circuit protection	S	-	-	-
9	Field selectable trip settings	S	-	-	-
10	Visible break with contacts visible through viewing windows and clear puffer tubes	-	O	O	O
11	Visible break by external neon voltage indicator lights	O	O	O	-
12	Operating handle orientation adaptors	O	O	O	-
13	Mechanical or key interlocks	O	O	O	-
14	Manual switching with remote cable operator	O	O	O	O
15	Motor-operators for local, remote or SCADA switching	O	O	O	O
16	Motor-operators, voltage and current sensors for Automatic Load Transfer Switching	O	O	O	O
17	Equipment mounted parking stands	O	-	S	-
18	Wall mounted parking stand	O	O	-	-

O - Optional Accessory S - Standard Feature (-) - Not Applicable



### Visible Break

Visible break option allows direct viewing of the switch contacts in the open and closed positions through clear puffer tubes and windows located on the switch tank.



### Neon Voltage Indicators

Available for 200 or 600 Amp elbow connectors, neon voltage indicators conveniently attach to the elbow test point provision to provide a flashing signal indicating the connection is energized during switching operations. Neon voltage indicators may be removed or replaced by a hot stick.



## Standard Options and Accessories



### Padmount Enclosures for Subsurface Switches

Extend the flexibility of subsurface switches to include padmount applications. Standard enclosures are 60" HIGH x 72" WIDE x 54" DEEP and will house 2- thru 6-way subsurface switches. The tamper-resistant enclosure provides plenty of room for cable training and switch operation with easy access thru a padlockable door.

Enclosures are constructed of weather-resistant 12-gauge mild steel, painted dark green. Enclosures are shipped knocked down, and come with stainless steel hardware, wind stops, venting, lifting, mounting provisions and instructions for easy field assembly.



### Parking Stands

Parking stands provide for grounding, testing, and isolating cable connections. Wall-mounted parking stands allow convenient elbow removal from subsurface switches in vault or padmount applications. Equipment-mounted parking stands are standard on LPG6 switches and are optional on PG6, PRG6, SRG6, AND SG6.



Wall mounted parking stands may be attached to the sides of the switch or to the vault.



Parking stands are standard on LPG6 and are located next to each bushing as shown above.

Photo shows typical parking stand arrangement for PG6 and HPG6 switches.



### Operating Handle Adapters

Operating handle adapters allow angle of handle to be changed for convenient switch operation in locations where the standard handle is inadequate. Adaptors bolt directly to operating handles for 45, 90, or "universal" 15 degree operating positions.



### Mechanical Interlocks

Mechanical interlocks prevent such unwanted operations as paralleling of feeders – a moveable stainless steel bar prevents the closing of one switch unless adjacent switch is open. Interlocks are bolt-on, and hookstick operable, and permit all standard operation features of the switch.

## Standard Options and Accessories

### Key Interlocks

Key interlock provisions may be added to switch operating handles to coordinate operation with other equipment such as preventing access to an energized compartment. The stainless steel bolt-on interlock provision will accept any standard B1E keylock. When ordering, specify desired locking arrangement: lock in closed position; lock in open position; or lock in both open and closed position.



### SF6 Refill Cylinders

SF6 refill cylinders provide a light-weight, convenient method of adding SF6 to a switch in the field should it ever become necessary. Tank contains enough SF6 for several refills.

Kit includes tank, regulator, valve and hose connection to the fill valve on the switch.



### Fused PufferPak Switches\*

Fused PufferPak Switches provide overcurrent protection for cable runs, transformers, motors, capacitor banks and other distribution system equipment.

SF6 Power Fuses, rated 3 thru 200 Amp, are non-venting and contained within bushing-connected molded rubber fuse-holders. Fuses are deadfront, submersible, hotstick replaceable and elbow-connected to the load-side.



### Current Limiting Fuse

Current limiting fuses, rated 40 Amp maximum, are contained within drywell fuseholders attached to the switch. The fuseholder seals and protects the fuse during operation and allows hotstick removal and replacement.



### Remote Cable Operators

Remote cable operators provide remote manual switching where hookstick, rope, or motor-drive switching prove impractical. A flexible, armored cable connects the switch operating handle to a remote rotary crank. Turning the crank operates the switch. Included are position indicators, padlock provisions and mounting brackets for bolt-on attachment to switch. Standard cable length is 20 feet with other lengths available in 10 foot increments.



Remote cable operator connection to switch tank and operating handle.

## Switch Automation Options

### Remote Operation with SCADA Interface

PufferPak SF6 switches can be easily upgraded for SCADA or fully automatic operation with the addition of state-of-the-art motor operators, controls, and current and voltage sensors as required.

Standard operating voltage is 24 VDC using a self-contained battery and charger which can be connected to any convenient customer-supplied 120 VAC source. For manual override in emergency situations, the motor operators are fitted with quick disconnect pins, which allow manual operation of the switch in the normal manner.

Control of the motor operators is attained using state-of-the-art current-sensing logic, eliminating the need for mechanical limit switch adjustment in the field.

Electronic controls are contained in a NEMA 4 enclosure, with swing-out panel, and a hinged, padlockable door, along with 20 ft. of control cable for each motor. NEMA 6P bolted cover style enclosures are also available for submersible applications.

SCADA interface is provided to accept either customer supplied RTU, or a complete package including RTU can be supplied. Various protocols are supported. Consult factory for details.

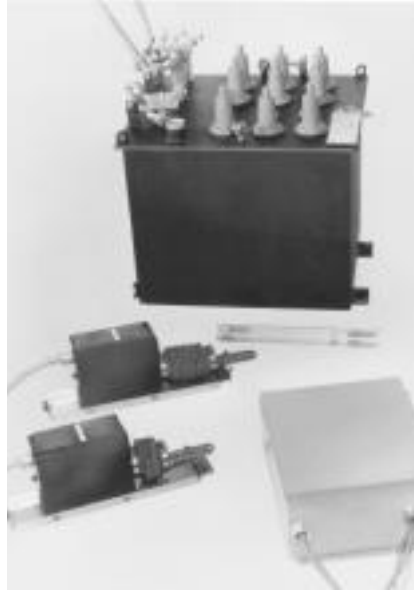

Pushbutton and SCADA control components



Quick disconnect motor attachment

### Automatic Transfer Control

The micro-processor based auto-transfer control is ideal for maintaining power to critical loads such as hospitals, airports, shopping centers, etc. A user-friendly LCD display allows field personnel to scroll through various parameters, following explicit, easy instructions.

The auto-transfer control is basically a IED with on board SCADA capability, removing need for separate RTU in various applications.

Several configurations are available including preferred/non-preferred feeder selection, as well as make before break on the return transfer to prevent a second outage to customers.

For non-protected loads, fault indicators are supplied to prevent transfer of a feeder onto a faulted circuit.

Voltage and current sensors are available for both 200 or 600 Amp elbows.



## Typical Specifications

### General

This specification outlines the requirements for manually operated SF6 filled load break switches for:

- m Subsurface
- m Padmount applications
- m Pole Top

The switch shall be:

- m Single phase
- m Three phase, with
  - m 2-way                    m 5-way
  - m 3-way                    m 6-way
  - m 4-way                    m other

circuit configuration. The unit will include 200 Amp deepwell or 600 Amp bushings per ANSI/IEEE 386. A one line diagram indicating the circuit configuration, number of switched ways, and type of bushings required will accompany this specification.

Switches must be furnished factory filled with an electrical grade of non-toxic, non-flammable SF6 gas, conforming to ASTM D-2472. A pressure gauge which provides visual status of both the insulating and interrupting dielectric must be included. 100% production testing shall include a mass spectrometer leak test, contact resistance, AC one minute withstand and corona extinction tests.

The completed unit must be capable of withstanding internal failure without explosion or fire and shall be capable of being mounted in any position for best cable training and operation.

### Switch Construction

The switch shall use deadfront, compact, sealed construction. The contact system, interconnecting bus, operating mechanisms, and bushings shall be enclosed by a corrosion-resistant mild or stainless steel tank. The switch must be maintenance free, all welded construction, eliminating the use of gasketed seals. T.I.G. inert gas welding with stainless steel filler rod shall be used to eliminate pinhole leaks and corrosion.

The operating shafts must be sealed by a flexible metal bellows (O-ring type seals are not acceptable).

Unless otherwise specified, cable connections, and operating accessories shall be located so only single side access is required for operation and installation. Operating handles shall be capable of being removed and stored or permanently attached.

Movement of the operating handles will actuate an internal spring mechanism causing the switch contacts to open or close and latch into position.

The spring operator will use compression springs for long life and will provide positive position indication. The switch contacts and interconnecting bus shall be plated copper with Belleville washers and locking fasteners to provide consistent pressure at bolted connections. The contacts shall be self-aligning, wiping type, incorporating tungsten copper arcing tips to prevent wear.

A puffer contact system for fast arc extinction along with a special internal absorbent shall be used for improved performance and to prevent arc by-products.

### Switches shall Include:

- Operating handles with padlock provisions in the open and closed position, capable of operation by hookstick or rope with direction of movement clearly indicated.
- Stainless steel nameplates providing information including ratings, contact position indication, circuit configuration and phase identification.
- Color coded pressure gauge for visual indication of normal operating range, enclosed in a protective housing to prevent damage.
- Brass filled valve for field addition of SF6, protected and sealed with a removable cap.
- 4/0 AWG clamp type ground lugs, one for each set of bushings.
- Stainless or mild steel switch tank for maximum corrosion resistance.
- 200 Amp deepwell or 600 Amp bushings, with protective shipping caps (elbows and inserts furnished by user).
- Lifting and mounting provisions.

# Typical Specifications

## Ratings and Performance

The load break switch shall be tested and rated per ANSI C37.71 and C37.72.

## Padmount Enclosure Construction

For padmount installations, a tamper-resistant housing shall be provided. The enclosure will be constructed of 12-gauge-thick mild steel, stiffened and cross-kinked for watershed and rigidity. All flanges shall overlap and interlock to discourage unauthorized entry. The design shall incorporate single side access to minimize the necessary space required for operation. Access to the switch and cable compartments shall be thru lightweight hinged doors and hood. The enclosure will be completely removable from the switch to facilitate installation, maintenance, and, if necessary, replacement.

## Padmount enclosures shall include:

- Recessed, 5/8"-11 threaded lifting provisions.
- Recessed padlock provision with penta-head security bolt.
- Mounting provisions using internal flange for anchoring.
- 300 series stainless steel hardware with the enclosure painted dark green (Munsell #7.0 GY 3.29/1.5) 3 MIL thick over a zinc rich primer.
- Door stops and stays to prevent accidental closing.

## Pole Top Construction

For Pole Top installations, the bushings shall be designed and tested per ANSI 386 in 200 Amp deepwell or 600 Amp apparatus style as required for elbow connections or shall be 600 Amp style fitted with molded rubber insulators for connection to air insulated distribution lines.

## Fault Interrupting Switch Construction

The load taps of padmount or submersible style switches shall be complete with a Resettable Fault Interrupter (RFI).

The interrupter shall be resettable with no consumable parts (e.g. fuses). As a safety precaution, the interrupter shall incorporate a trip free mechanism, which will cause the device to trip open in the event that the operator should close into a fault, with no effect felt through the operating handle.

The interrupter shall be a true three-phase internal mechanism. Devices that are mechanically ganged externally are not acceptable.

The interrupter shall also act as a three-phase group operated load-break switch.

Interrupter status shall be provided by means of a mechanical position indicator consisting of a magnetic strip activated by a vertical rod connected to the moving contact of the vacuum interrupter.

Over current sensing shall be accomplished with an electronic trip control. The control shall use external current transformers to sense and monitor load currents. Trip and time-current curves shall be field selectable. Trip setting may be changed while switch is energized so that service is not interrupted.

An optional LCD display, or RS232 port shall be provided in order to obtain real time current data and time and cause of last trip.

Electronic control shall be suitable for future remote trip and/or reset via supervisory control.

# Installation and Operation

## Typical Switch Installation

PufferPak switches are shipped factory filled with SF6 and include all necessary accessories for installation except for elbows, which are furnished by the user.

1. Uncrate, attach handles, and check operation.
2. Mount switch into position, leaving sufficient room for cable training and operation. Install to floor, ceiling, or walls for best utilization of space.
3. Train and connect cables and ground leads. Elbow adaptors and extensions may be used to aid cable training or facilitate 200 Amp connections.
4. Energize and operate switch within its ratings.



Typical Padmount Application

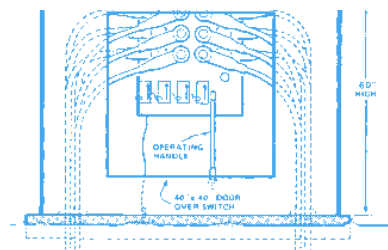

Subsurface Switch with Optional Padmount Enclosure

## Switch Operation

To open or close switch, move operating handle toward desired position. At the end of the handle travel, an internal spring-operated mechanism will move contacts to position shown on indicator. The switch may be operated remotely using a hookstick or rope and may be padlocked into position.

## Application and Practical Usage of SF6

The application of gas-filled equipment requires some knowledge of the practical handling of SF6. The following considerations can help in establishing the proper operating procedures.

### A. Availability and Specifications

SF6 is readily available from any of several suppliers, including

Allied Chemical and Air Products. The use of commercial-grade SF6 per ASTM D-2472 is recommended and may be obtained in cylinder sizes ranging from 6 to 115 lbs. SF6 is a colorless, odorless, non-toxic, and non-flammable gas.

### B. Operating and Maintenance

PufferPak switches have been designed and evaluated using the levels established by ANSI C37.71 standards, which assures the normal life of the equipment without any maintenance. In practice, as long as the design ratings are not exceeded, the only maintenance required is the regular monitoring of SF6 pressure and checking of the equipment for proper working condition. The switch is equipped with a color-coded pressure gauge which indicates the quantity of SF6 gas and the quality of the sealing system.

### C. Field Adding of SF6

Switches are shipped factory filled with SF6 to approximately 10 PSIG. Although gauge pressure varies with temperature, the switch should always be operated within its normal pressure range of 2-15 PSIG. If field addition of SF6 becomes necessary, add the SF6 through the fill valve provided on the tank.

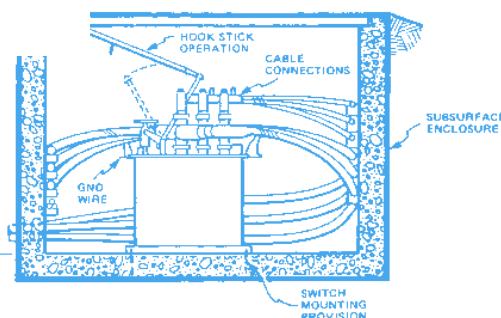

Subsurface Application

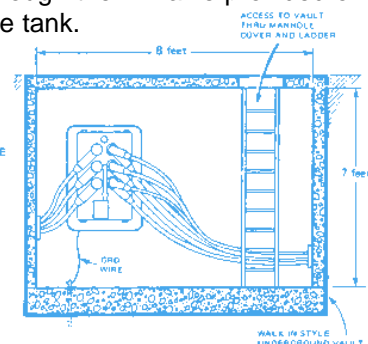

Subsurface Vault Application

Calle Privada de Pimentel #6306 Colonia Lagos

Ventas1@serviciosintegralesmineros.com

Telefonos: (614) 306 20 56 o 335 03 27

Web: [www.simmexico.com.mx](http://www.simmexico.com.mx)

Chihuahua, Chihuahua, México.